



Klaas



Tractable
≤3,5t
Permis BE

K23-33 City



Abaque

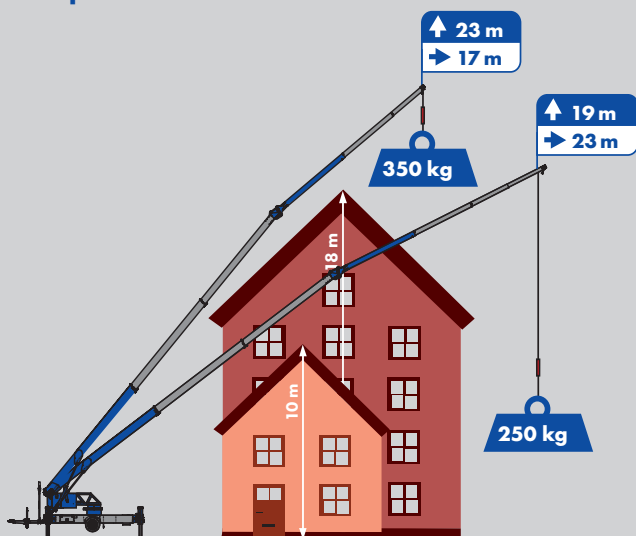

▶ Hauteur sous crochet max. 33 m

▶ Charge max. 1 500 kg

▶ 23 m de portée avec 250 kg

Abaque de charge

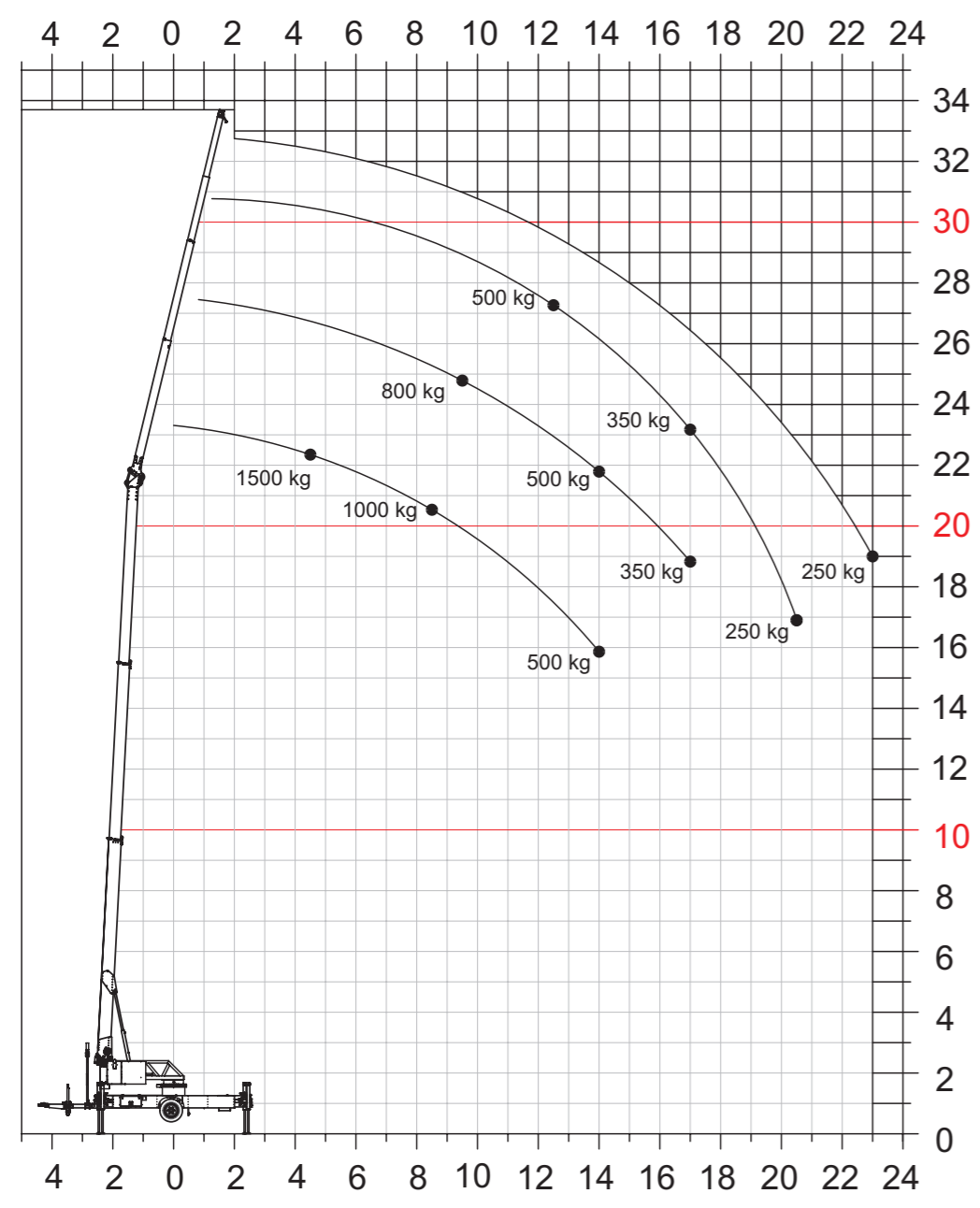

Plage de travail

Charge	Portée	Hauteur
250 kg	23,00 m	19,00 m
350 kg	17,00 m	23,00 m
500 kg	14,00 m	21,50 m
800 kg	9,50 m	24,50 m
1.000 kg	8,50 m	20,50 m
1.500 kg	4,50 m	22,00 m

Abaque nacelle

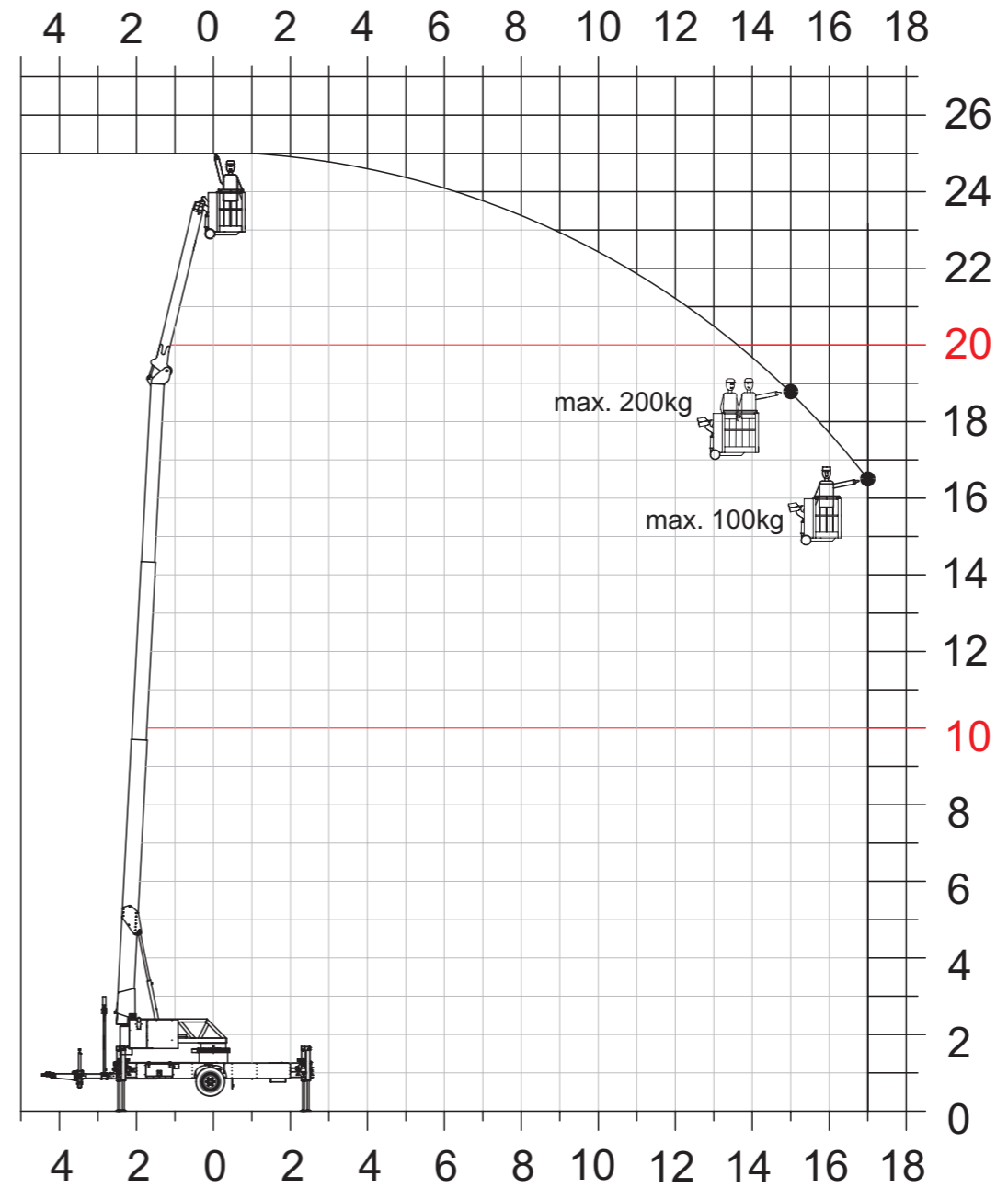



Plage de travail HA 2/200

Charge	Portée	Hauteur
100 kg	17,00 m	16,50 m
200 kg	15,00 m	19,00 m
Hauteur max.		25,00 m





Données techniques

Capacité	
Charge utile max.	1.500 kg
Capacité du treuil	1.500 kg

Mât	
 Hauteur sous crochet	33,00 m
 Longueur de flèche	34,10 m
 Hauteur de travail jusqu'à la flèche	21,61 m
Rotation de la tourelle	360° infini

Flèche	
Portée (1.500 kg)	4,98 m
Extension 1 (800 kg)	8,27 m
Extension 2 (500 kg)	10,40 m
Extension 3 (250 kg)	12,31 m

Stabilisation en H	
 Stabilisation (max.) L x l	4,80 x 5,05 m
 Largeur stabilisation min.	2,85 m
 Largeur de stabilisation (1 seul côté)	3,95 m

Motorisation	
D	Moteur Diesel
RH	Moteur hybride

Dimensions repliées	
Hauteur	2,59 m
Largeur	2,27 m
Longueur	9,24 m
Poids de l'ensemble	3,5 t

Flèche

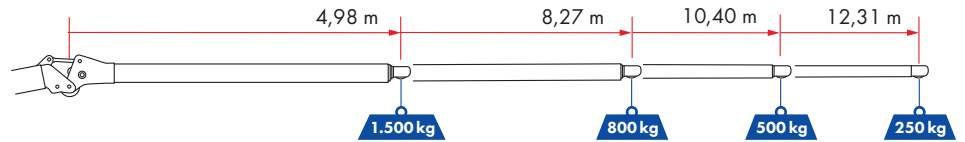

Stabilisation

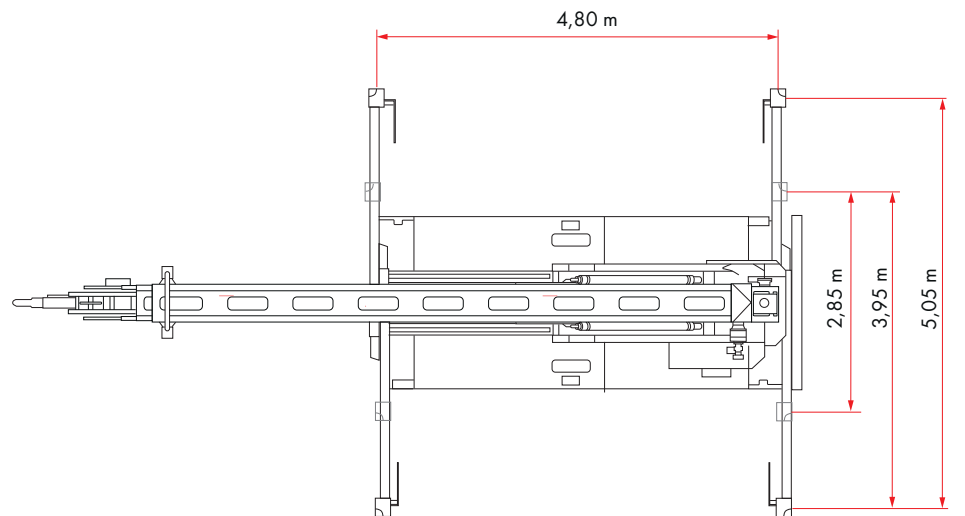

Dimensions

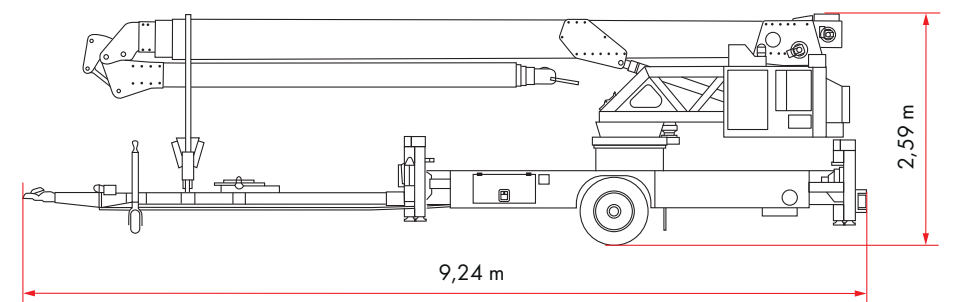

Sous réserve de modifications techniques. Toutes les dimensions sont des valeurs approximatives et dépendent du véhicule porteur concerné.

Des modifications des fonctions et des performances restent réservées. Les indications reflètent les performances de

11/2025

K23-33 City



Nos agences

Agen	Nantes
Chambéry	Nanteuil-le-Haudouin (siège)
Clermont-ferrand	Salon-de-Provence
Joinville	Strasbourg
Le Mans	

 [klaasbydeumin](#)

 [klaasallroad](#)

 [klaasallroad](#)

Klaas

Klaas All Road - Location Vente SAV Formation Financement

Siège social : 6 allée des primevères - 60440 Nanteuil-le-Haudouin

Tél : 01 43 00 55 96 | contact@klaas.fr